



WARNING:

Failure to install or use this product according to manufacturer's recommendations may result in property damage, serious injury, and/or death to those you are seeking to protect.



Do not install and/or operate this safety product unless you have read and understand the safety information contained in this manual.

1. Proper installation combined with operator training in the use, care and maintenance of emergency warning devices are essential to ensure the safety of you and those you are seeking to protect.
2. Exercise caution when working with live electrical connections.
3. This product must be properly grounded. Inadequate grounding and/or shorting of electrical connections can cause high current arcing, which can cause personal injury and/or severe vehicle damage, including fire.
4. Proper placement and installation is vital to the performance of the warning device. Install this product so that output performance of the system is maximized and the controls are placed within convenient reach of the operator so that he/she can operate the system without losing eye contact with the roadway.
5. It is the responsibility of the vehicle operator to ensure daily that all features of this product work correctly. In use, the vehicle operator should ensure the projection of the warning signal is not blocked by vehicle components (i.e. open trunks or compartment doors), people, vehicles or other obstructions.
6. The use of this or any other warning device does not ensure all drivers can or will observe or react to an emergency warning signal. Never take the right-of-way for granted. It is your responsibility to be sure you can proceed safely before entering an intersection, drive against traffic, respond at a high rate of speed, or walk on or around traffic lanes.
7. This equipment is intended for use by authorized personnel only. The user is responsible for understanding and obeying all laws regarding warning signal devices. Therefore, the user should check all applicable city, state, and federal laws and regulations. The manufacturer assumes no liability for any loss resulting from the use of this warning device.
8. This device produces high sound pressure levels which can cause damage to hearing. Appropriate safety precautions should be taken to minimise exposure.

SPECIFICATIONS:		12V	24V
Part Number (Kit)		620-M3000-12	620-M3000-24
Amplifier Size (mm)		180L x 90W x 50H	180L x 90W x 50H
Controller Size (mm)		90L x 17W x 50H	90L x 17W x 50H
Input Voltage Range		10-15 VDC	20-30 VDC
Current Draw	Standby	<0.04A	<0.04A
	Max	10A	6A
Ambient Operating Temperature		-10 to +50 C	-10 to +50 C

INSTALLATION & MOUNTING:

Before installation, examine the siren and controller for transit damage. Do not use damaged or broken

Important!

This unit is a safety device and it must be connected to its own separate, fused power source to assure its continued operation should any other electrical accessory fail.

Caution:

When drilling into any vehicle surface, make sure the area is free from any electrical wires, fuel lines, vehicle upholstery, etc. that could be damaged.

Before proceeding with installation, plan all wiring and cable routing.

M3000 SERIES SIREN CONTROLLER

Determine the best mounting position for the controller in the vehicle. Mount the unit on any suitable clean flat surface. If the vehicle is fitted with airbags, ensure that the chosen mounting position will not effect their deployment.

Refer to diagram below for connection details.

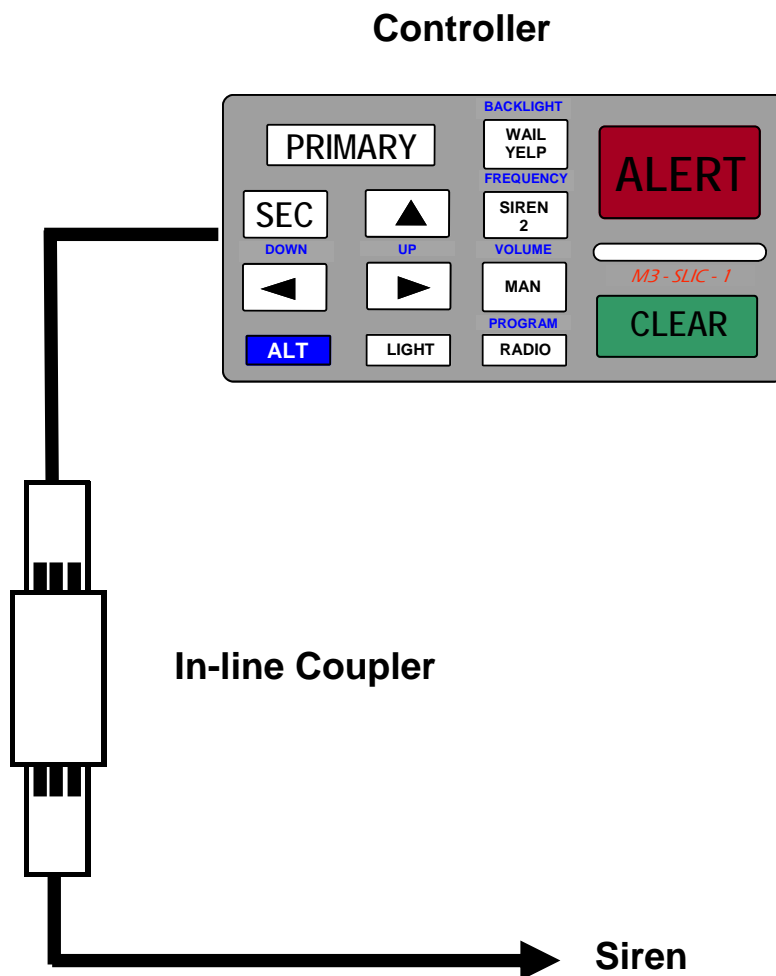

M3000 SERIES SIREN AMPLIFIER

Important! This system must be securely mounted in an area with adequate ventilation and no direct exposure to water as excess heat or water ingress may adversely affect the operation of the siren and safety of the siren.

During normal operation, the M3000 Series Siren can produce significant amounts of heat. With this in mind the unit should be mounted in a non-confined area. The recommended positions for the unit are on the floor of the vehicle under the front passenger seat, or around the front passenger kick panel area.

Screw the mounting bracket to a flat surface. Place the M3000 Series Siren in the brackets, such that the connectors at one end are accessible. Thread the fastening straps over the unit and through the slot on the other side of the bracket. Pull back firmly on the strap and fasten it down.

WIRING INSTRUCTIONS



Caution! This device produces high sound pressure levels which can cause damage to hearing. Appropriate safety precautions should be taken to minimise exposure.

End view of M3000 Series Siren

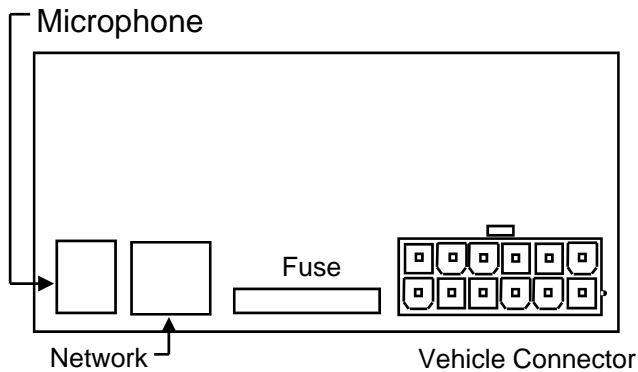

Vehicle Connector Socket

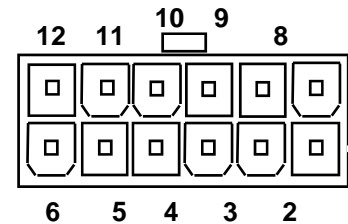

12 - GND	11 - POWER (+)	10 - RADIO IN
6 - GND	5 - POWER (+)	4 - RADIO IN
9 - BONNET	8 - PARK LIGHT	7 - SPEAKER +
3 - HORN	2 - 60W LIMIT	1 - SPEAKER -

1. A wiring harness which plugs into the vehicle connector socket is supplied with the M3000 Series Siren. The wires in this harness are detailed in the table below.
2. Do not connect the red power wires of the harness to the battery terminal until all other connections have been made to the unit.
3. Check that a 15A fuse is installed in the fuse holder of the M3000 Series Siren.
4. Plug the harness into the vehicle connector socket.
5. Connect the red power wires to the battery terminal.
6. Connect the cable from the microphone to the MICROPHONE socket on the M3000 Series Siren.
7. Connect the cable from the controller to the NETWORK socket on the M3000 Series Siren. The controller should emit a short "beep" and be ready for use.

COLOUR	FUNCTION	CONNECTION DETAILS
RED	POWER	Both red power sirens must be fused at a power source, using the shortest possible wire length. Refer Wiring Diagram.
BLACK	GROUND	Both black ground wires must be connected to either battery negative or an appropriate ground point on the vehicle.
WHITE	SPEAKER	The white figure-8 speaker wires connect directly to the siren speaker.
GREY	RADIO	The grey figure-8 radio input wires should be connected to the auxiliary or speaker output of a two-way radio. The radio input is designed for a 5Vpp signal level.
GREY	HORN	The horn wire must be connected into the vehicle horn circuit such that it connects to the ground when the vehicle horn is activated. Usually this is done at the horn relay. Refer Wiring Diagram.
YELLOW	BONNET	The bonnet wire input is normally used to activate the primary and takedown lighting functions on the M3000 Series Siren from outside the vehicle, via a switch mounted around the bonnet area of the vehicle. The bonnet input is activated by connecting this wire to either +VE or ground.
BLUE	PARK	Connect the blue park wire into the vehicles park light circuit. This input activates the controller keypad backlighting. The controller backlight will not function unless this wire is connected.
PURPLE	60W LIMIT	If connected to either +VE or ground, this input will restrict the output power of the siren to a maximum of 60W. If 100W output is desired, leave this wire unconnected.

M300 SERIES SIREN RELAY CONNECTOR

The M3000 Series Siren is equipped with 8 relays for switching different lighting loads. LEDs located above each output terminal indicate the relay status as well as fuse faults. If an output fails check the fuse on the power feed and the internal fuses.

It is necessary to provide positive supply to the 3 input terminals (pins 1-3). Each pin provides power to a group of relays, which enables the installer to share the lighting loads over different vehicle circuit breakers if required. Refer to the wiring diagram and table below for relay connection details.

Use 1/4" QC insulated terminals to connect as detailed below as well as in the wiring diagram on the following page.

The relay connector pin-out is as follows:

Lighting Relay Connections

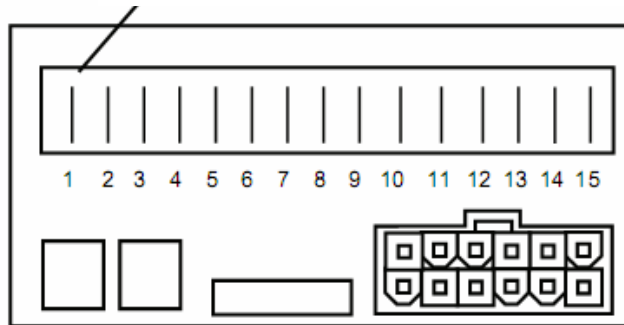

End View of M3000 Series Siren

PIN	FUNCTION		MAX. CURRENT	MAX. COMBINED CURRENT	FUSING REQUIREMENTS
	809-001-HP	809-001			
	809-002-HP	809-002			
1	Power feed for pin 5		20A	-	External 25A fuse required on each individual feed at battery.
2	Power feed for pins 7-8		20A	-	
3	Power feed for pins 10-14		20A	-	
4	Not used		-	-	
5	Primary warning lights	Intersection lights	20A	20A	No additional fusing required
6	Not used		-	-	
7	Secondary warning lights	Primary warning lights	20A	20A	No additional fusing required
8	Intersection lights	Secondary warning lights	15A		Internal 15A fuse
9	Not used		-	-	
10	Left alley light		15A	20A	Internal 15A fuse for each output
11	Right alley light		15A		
12	Sign light		15A		
13	Headlight flasher		15A		
14	Takedown lights		15A		
15	Not used		-	-	

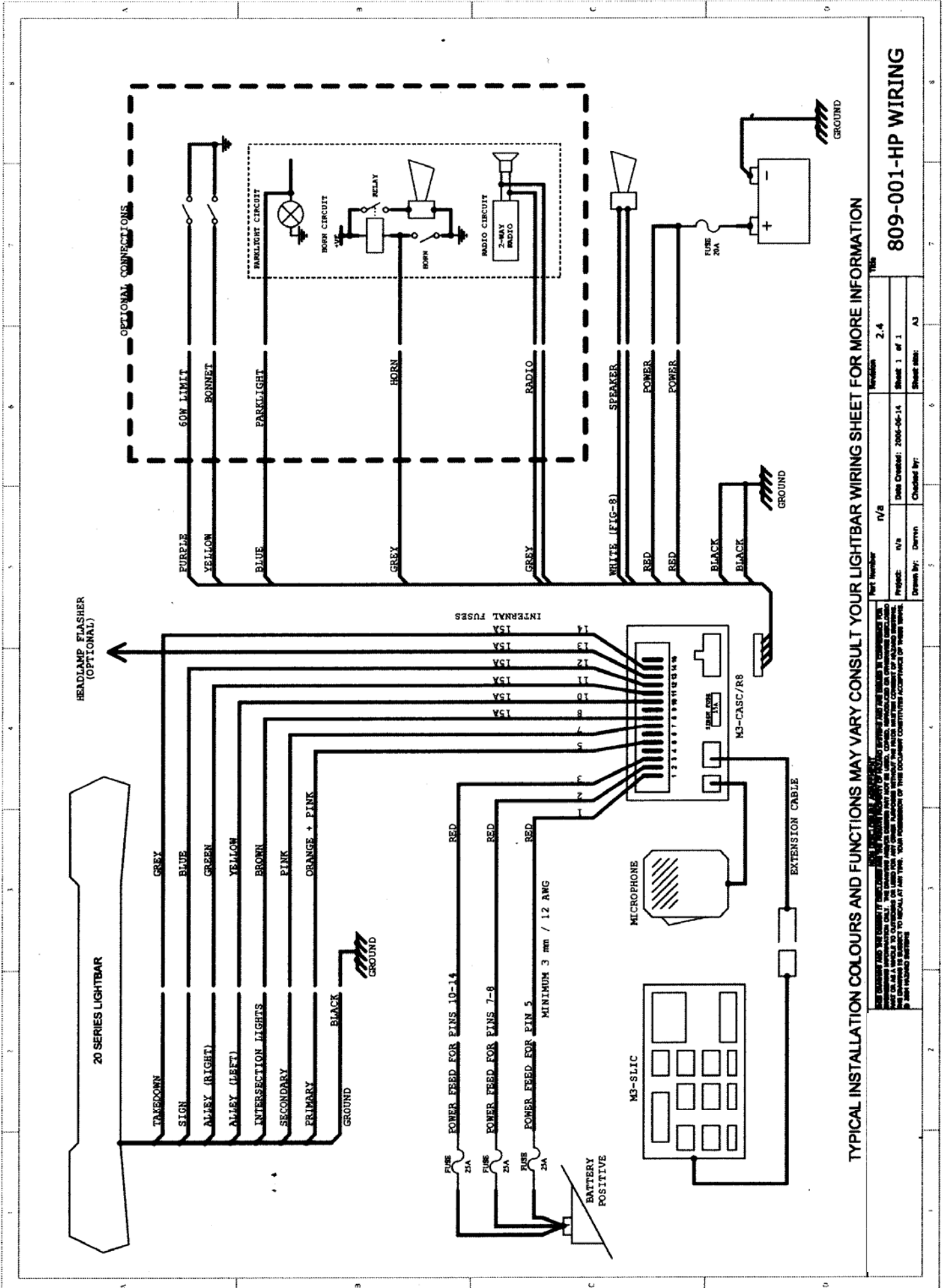

TYPICAL INSTALLATION COLOURS AND FUNCTIONS MAY VARY CONSULT YOUR LIGHTBAR WIRING SHEET FOR MORE INFORMATION

809-001-HP WIRING

Net Number	IV/3	Revision	2.4
Project	IV/3	Date Created	2005-06-14
Drawn By	Derran	Checked By	AJ
Sheet No.	1 of 1		

THIS DOCUMENT AND THE CONTENTS THEREOF ARE THE PROPERTY OF AUSTRALIAN WARNING SYSTEMS AND SHALL BE KEPT IN CONFIDENCE FOR THE EXCLUSIVE USE OF THE CUSTOMER. IT IS NOT TO BE REPRODUCED, COPIED, OR TRANSMITTED IN ANY FORM OR BY ANY MEANS, ELECTRONIC OR MECHANICAL, INCLUDING PHOTOCOPYING, RECORDING, OR BY ANY INFORMATION STORAGE AND RETRIEVAL SYSTEM, WITHOUT THE WRITTEN PERMISSION OF AUSTRALIAN WARNING SYSTEMS. THE CUSTOMER AGREES TO HOLD AUSTRALIAN WARNING SYSTEMS HARMLESS FROM ALL LIABILITY IN CONNECTION WITH THE USE OF THIS DOCUMENT. THIS DOCUMENT IS SUBJECT TO RECALL AT ANY TIME. YOUR PERMISSION OF THIS DOCUMENT CONSTITUTES ACCEPTANCE OF THESE TERMS AND CONDITIONS.

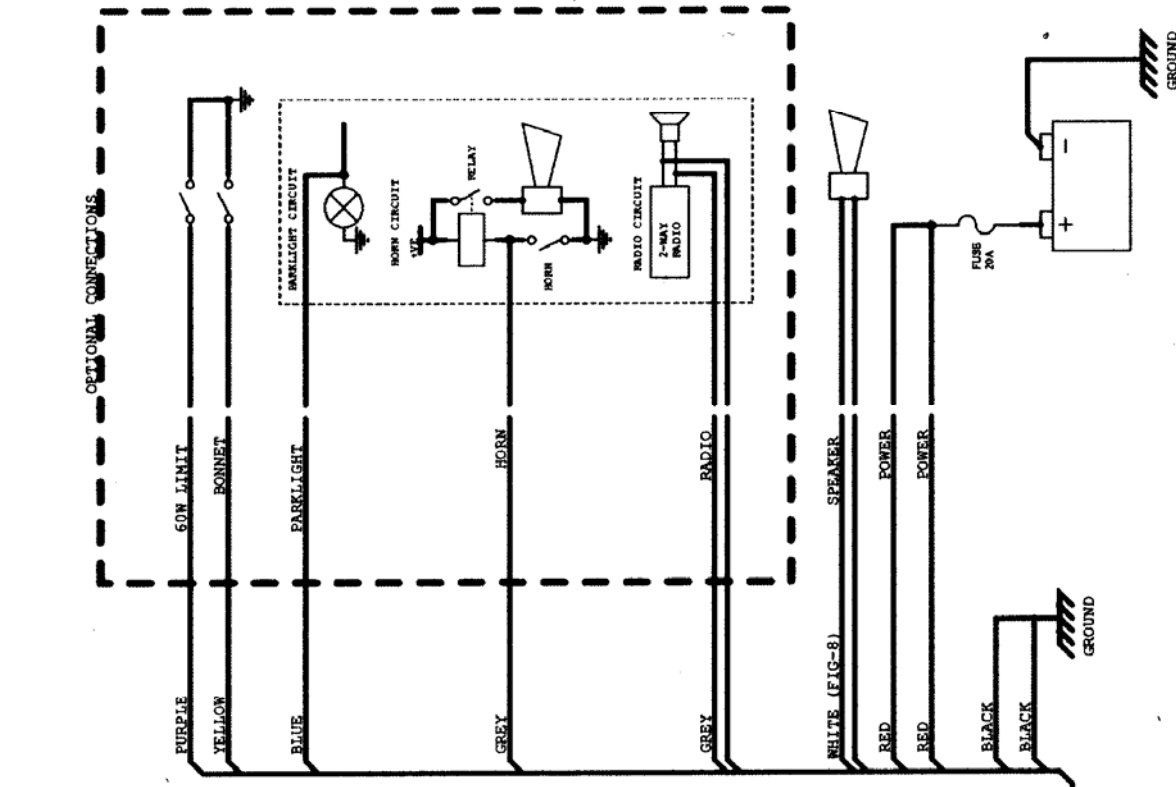
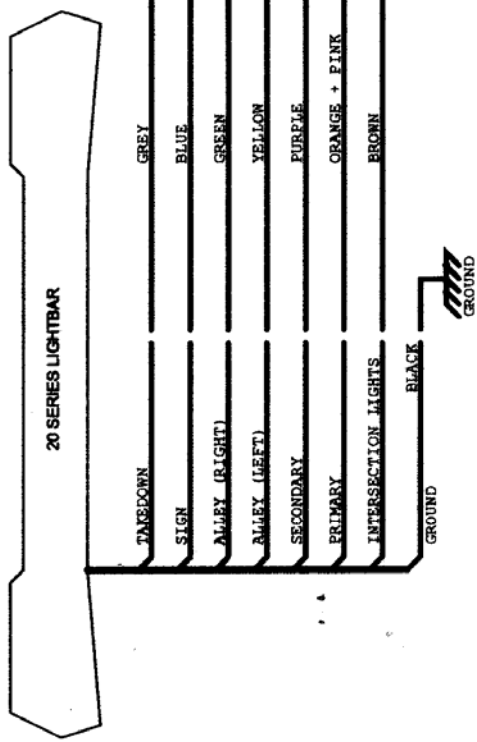

TYPICAL INSTALLATION COLOURS AND FUNCTIONS MAY VARY CONSULT YOUR LIGHTBAR WIRING SHEET FOR MORE INFORMATION

<p>THIS DOCUMENT IS THE PROPERTY OF AUSTRALIAN WARNING SYSTEMS. IT IS TO BE USED ONLY FOR THE PURPOSES SPECIFIED IN THE TITLE. IT IS NOT TO BE REPRODUCED OR TRANSMITTED IN ANY FORM OR BY ANY MEANS, ELECTRONIC OR MECHANICAL, INCLUDING PHOTOCOPYING, RECORDING, OR BY ANY INFORMATION STORAGE AND RETRIEVAL SYSTEM. PERMISSION IS GRANTED TO REPRODUCE THIS DOCUMENT FOR PERSONAL USE ONLY. ALL OTHER RIGHTS ARE RESERVED. © 2008 AUSTRALIAN WARNING SYSTEMS</p>			
Part Number	n/s	Revision	1.3
Project	n/s	Date Created	2008-09-05
Drawn by	Derren	Checked by	AJ
		Sheet 1 of 1	809-001 WIRING

